

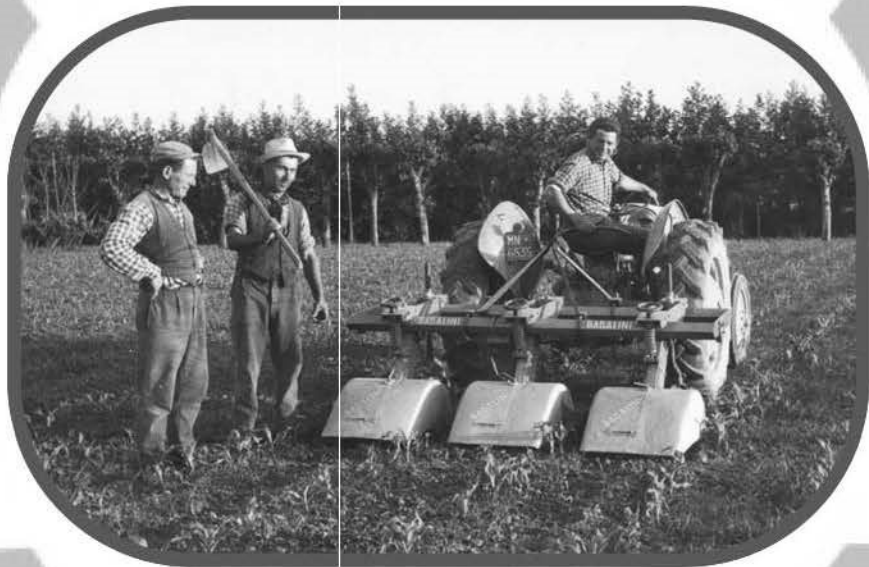

# MULTI-ROW ROTOTILLERS

多行-迴轉式大型中耕機



1961  
THE FIRST







# MULTI-ROW ROTOTILLER

# CERES

The vast range of accessories to complete this model as fertilizer distributor, ridging units, steering unit, kit for closing for the road transport, allow to manufacture the personalized equipment to every customer. In practice we manufacture the machine according to the specifics of our customer. So the farmer has not to purchase the machine he finds in commerce, but it is the manufacturing firm that moulds the equipment to his measure.



# CERES MCn/

STANDARD EQUIPMENT:

CE Regulations equipments

Oscillant protections

hain ASA 60-H

Frame in cast steel

High resistant blades and bolts

Cardan shaft with safety bolt

Square transmission shaft 30 mm

Couple wheels with bearings D=360 mm

Chain box in cast steel with side window for inspection

## FRAME SECTION

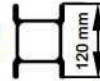

MOD. "NARROW" (SS)		FOR ROWS OF mm 300-350 WORK mm 185-220 (BONNET)			
HP	MODEL	UNITS NR.	ROWS NR.	FRAME m	WEIGHT kg
40-45	MCn/2SS	2	1	1,60	330
40-50	MCn/3SS	2	2	1,80	380
45-50	MCn/4SS	4	3	2,00	430
45-50	MCn/5SS	5	4	2,40	490
50-60	MCn/6SS	6	5	2,40	580
50-60	MCn/7SS	7	6	3,00	640
MOD. "STANDARD" (ST)		FOR ROWS OF mm 450-500 WORK mm 290-340 (BONNET)			
40-45	MCn/4ST	4	4	2,00	450
40-50	MCn/5ST (3+2)	5	4	2,40	530
45-50	MCn/6ST (4+2)	6	5	3,30	600
45-50	MCnR/6ST (4+2)	6	5	3,30/2,50	640
50-60	MCn/7ST (5+2)	7	6	3,30	670
50-60	MCnR/7ST (5+2)	7	6	3,30/2,50	700
MOD. "MEDIUM LARGE" (ML)		FOR ROWS OF mm 600-650-700 WORK mm 390-440-490 (BONNET)			
40-45	MCn/3ML	3	-	2,00	330
50-60	MCnR/5ML (3+2)	5	4	3,30/2,50	620
MOD. "LARGE" (L)		FOR ROWS OF mm 700-750-800 WORK mm 540-590-650 (BONNET)			
30-45	MCn/2L	2	-	2,00	360
45-55	MCn/3L	3	-	2,40	460

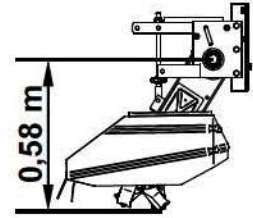

Code 5034B

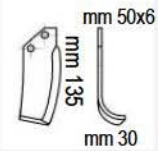

Code 5034

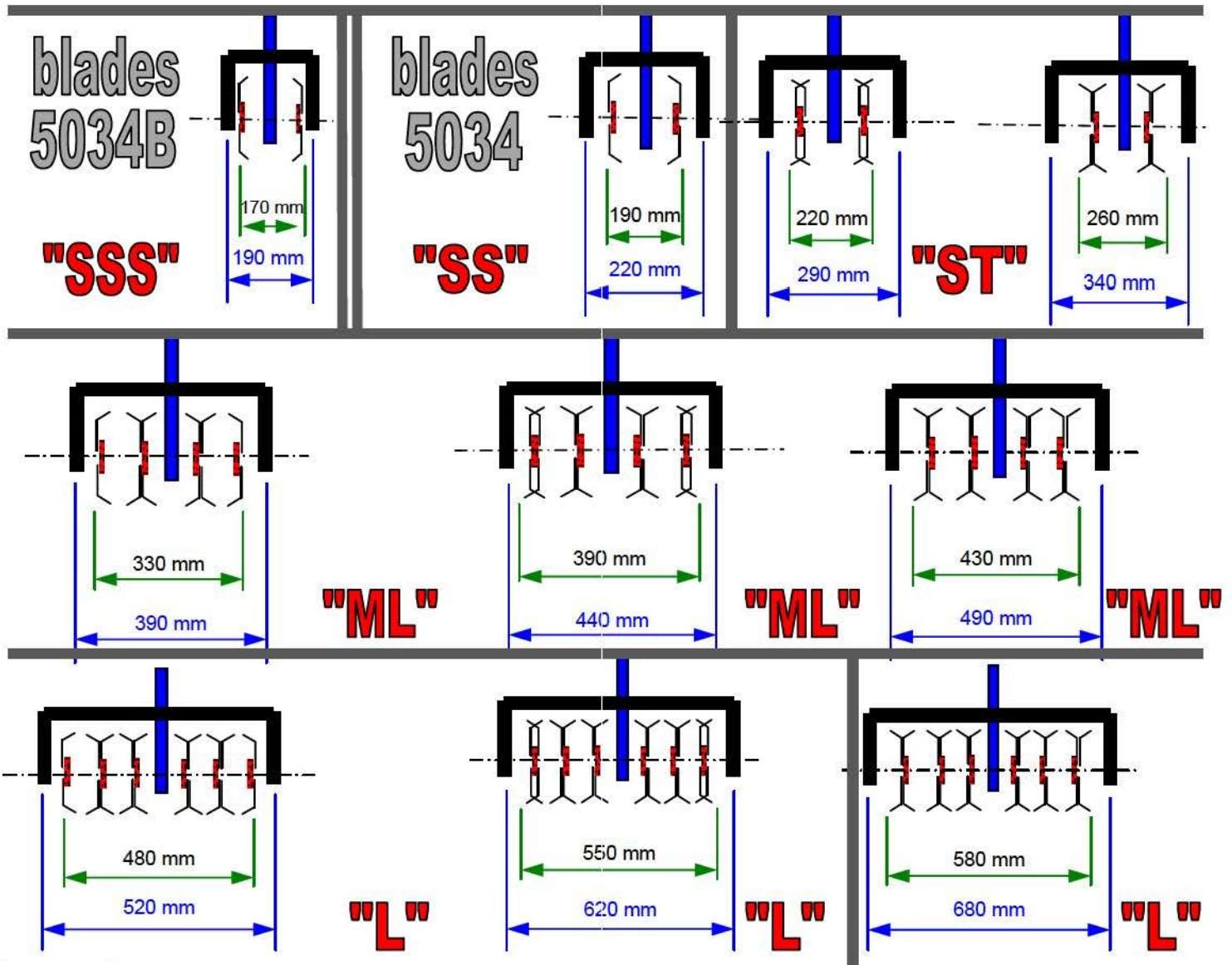
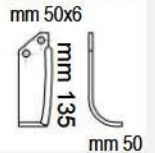

# CERES





# MULTI-ROW ROTOTILLER

# ERMES

# MEn/

## FEATURES

FRAME IN STRUCTURAL TUBULAR  
ASA 80 H STRENGTHENED CHAIN  
CLEARANCE UNDER THE SHAFT mm 630  
HEXAGONAL TRANSMISSION ON SHAFT 41 mm  
OSCILLANT PROTECTIONS  
HIGH RESISTANT HOES AND BOLTS  
CHAIN BOX IN STEEL WITH SIDE WINDOW FOR INSPECTION  
COUPLE OF WHEELS WITH BEARINGS ON FRAME  
CARDAN SHAFT WITH SAFETY BOLT

## OPTIONAL ON REQUEST

ROTATING SHAFT PROTECTIONS  
FRONT TINE  
MANUAL OR HYDRAULIC STEERING UNIT  
RIDGING UNITS  
FERTILIZER SPREADER WITH DIFFERENT CAPACITY  
CLOSING SYSTEM OF THE FRAME FOR THE TRANSPORT ON ROAD



ITS CHARACTERISTICS MAKE THE MULTI-ROW ROTOTILLER MODEL ERMES MEn/ PARTICULARLY PROPER FOR WORK ON CROPS WITH ROWS FROM 45 TO 70 cm.

**THE TRADITIONAL ONE.** THE MODEL MEn/ IS THE HEIR OF THE FIRST MULTI-ROW ROTOTILLER IN THE WORLD. IT ADAPTS ITSELF TO ALL THE CULTIVATIONS, FROM FENNEL TO BEET.

DESPITE IT IS NOT TOO MUCH THICK, IT GUARANTEES A GREAT STURDINESS.

MACHINES OF THIS TYPE ARE KNOWN TO HAVE BEEN WORKING FOR 30 YEARS, WITHOUT HAVING THE MINIMUM PROBLEM.



# ERMES

## FRAME SECTION

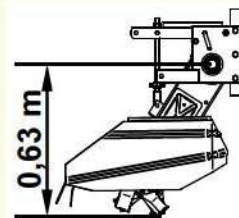

### STANDARD EQUIPMENT:

EC safety guards

Oscillant protections

Frame in cast steel

Strengthened chain ASA 80H

Hexagonal transmission shaft 41 mm

Cardan shaft with safety bolt

Extra resistant blades and bolts

Chain box in cast steel with side window for inspection

### Code 5145C

mm 50x8



## OPTIONAL

MOD. "STANDARD" (ST)		FOR ROWS OF mm 450-500 WORK mm 290-340 (BONNET)			
HP	MODEL	UNITS NR.	ROWS NR.	FRAME m	WEIGHT
35-45	MEn/4ST	4	4	2,00	790
40-55	ME/5ST (3+2)	5	4	2,40	930
50-70	MEn/6ST (4+2)	6	5	3,00	1050
50-70	MEnR/6ST (4+2)	6	5	3,20/2,50	1100
60-80	MEn/7ST (5+2)	7	6	3,20	1000
60-80	MEnR/7ST (5+2)	7	6	3,20/2,50	1050
MOD. "MEDIUM LARGE" (ML)		FOR ROWS mm 600-650-700 WORK mm 410-460-510 (BONNET)			
30-40	MEn/2ML	2	3	2,00	470
30-40	MEn/3ML	3	-	2,00	670
50-70	MEn/5ML (3+2)	5	4	3,00	970
50-70	MEnR/5ML (3+2)	5	4	3,20/2,50	1030
MOD. "LARGE" (L)		FOR ROWS OF mm 700-750-800 WORK mm 510-560-610 (BONNET)			
30-45	MEn/2L	2	-	2,20	480
40-60	MEn/3L	3	-	2,20	680
60-80	MEn/5L (3+2)	5	4	3,20	980
60-80	MEnR/5L (3+2)	5	4	3,20/2,50	1040
70-100	MEn/7L (5+2)	7	6	4,60	1250
MOD. "SUPER LARGE" (SL)		FOR ROWS OF mm 900-950-1000 WORK mm 670-720-770 (BONNET)			
40-60	MEn/2SL	2	2	2,00	550
60-75	MEn/3SL (1+2)	3	3	2,40	750

MEn/ = fixed frame  
MEnR/ = mechanical folding frame  
MEnV/ = hydraulic folding frame







# ERMES





# SIRIO

## MULTI-ROW ROTOTILLER mod. MSn/

### HIGH EFFICIENCY MULTI-ROW ROTOTILLERS

#### SUITABLE FOR:

- MAIZE
- SUNFLOWERS
- SOYA BEANS
- TOMATOES
- POTATOES
- CABBAGES
- ARTICHOKES
- CHRISTMAS PINES
- SALAD
- SUGAR BEETS
- OFFICIAL PLANTS
- STRAWBERRIES
- ROSES
- CHICORY
- FENNEL
- ASPARAGUS
- TULIPS
- COTTON



#### FOLDING MODELS FOR ROAD CIRCULATION

- MANY MODELS ARE AVAILABLE WITH ROAD CLOSING FOR TRANSPORT.
- THE MODEL WITH MECHANICAL CLOSING IS SUPPLIED WITH A SPECIAL UPSETTING SPRING WHICH FACILITATES THE PHYSICAL EFFORT.
- THE HYDRAULIC MODEL IS SUPPLIED WITH BLOCK VALVES AND AUTOMATIC LIMIT STOP, THAT IS IT IS NOT NECESSARY TO GET OFF THE TRACTOR TO INSERT THE LOCK-PIN.
- THE MODEL FOR MAIZE IN 6 ROWS FOLDS TWO TILLING UNITS AT

#### IMPORTANT FEATURES

IN FACT BADALINI HAS INVENTED ALSO THE NAME :

**"Multifera".**

THE PRESENT MODELS ARE THE EVOLUTION OF THE FIRST AND REAL

**"Multifera".**

THE COMPUTER - ASSISTED DESIGN THROUGH THE MODERN SYSTEMS KEEPS IN CONSIDERATION THE GREAT EXPERIENCE ACCUMULATED DURING THE LAST DECADES.

IT IS POSSIBLE TO COMPLETE THE MACHINES WITH MECHANICAL OR HYDRAULIC STEERING UNIT, WITH BACK RIDGING UNITS WITH MOULDBOARDS OR DISCS.

ANOTHER IMPORTANT ACCESSORY IS THE FERTILIZER DISTRIBUTOR. MANY VERSIONS ARE AVAILABLE ALSO WITH SUFFICIENT CAPACITY TO CONTAIN A WHOLE SACK OF UREA.

BADALINI MULTI-ROW ROTOTILLERS HAVE BEEN STUDIED TO WORK IN ALL CONDITIONS, ALSO THE MOST DIFFICULT.

THE EXCEPTIONALLY RESISTANT CHAIN BOXES ALLOW THE MACHINE TO WORK ALSO IN SOILS WITH STONES.

THE FRAME IN EXTRUDED SECTION MAKES THE MACHINE PARTICULARLY STIFF AND SOLID. FOR THIS WE CAN PRODUCE TILL 6 METRES ROTOTILLERS WITHOUT DAMAGING THEIR STRENGTH.

MANY FITTINGS AND VERSIONS MAKE THE MACHINE EXTREMELY MULTIPLE AND VERSATILE.



**Multi-row rototiller mod. MSn/4(2SL+2L) working in tomatoes with hydraulic folding frame**



#### EXCEPTIONAL HOURLY PRODUCTIVITY

IT IS POSSIBLE TO WORK AT HIGHER SPEED THAN THE OTHER NORMAL MULTI-ROW ROTOTILLERS.

THE PARTICULAR TECHNOLOGY OF THE MACHINE MAKES POSSIBLE A DEEPLY PENETRATION ALSO IN VERY CLAYEY AND HEAVY SOILS.

THE HIGH ROTATION SPEED ALLOWS THE COMPLETE ELIMINATION OF WEEDS WITH CONSIDERABLE SAVINGS ON HERBICIDES CONSUMPTION.

THE QUALITY OF MATERIALS REDUCES THE QUANTITY OF NEEDED POWER.

#### PARTICULAR OF HYDRAULIC FOLD





# SIRIO

## FRAME SECTION

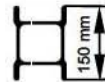

### STANDARD EQUIPMENT:

- EC safety guards*
- Cardan shaft with safety bolt*
- High resistant blades and bolts*
- Hexagonal transmission shaft 41 mm*
- Strengthened chain ASA 80H*
- Frame in cast steel*
- Oscillant protections*
- Front tine on each tilling unit (optional)*
- Chain box in cast steel with side window for inspection*

### Code 5145C

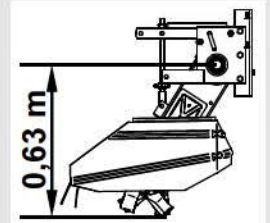

## OPTIONAL



MOD. "STANDARD" (ST)		FOR ROWS OF mm 450-500 WORK mm 290-340 (BONNET)			
HP	MODEL	UNITS NR.	ROWS NR.	FRAME m	WEIGHT
70-90	MSn/6ST (4+2)	5	4	3,00	900
60-90	MSn/7ST (5+2)	7	6	3,20	1020
60-90	MSnR/7ST (5+2)	7	6	3,20/2,50	1070
80-120	MSn/13ST (11+2)	13	12	6,00	1450
90-120	MSnI/13ST (11+2)	13	12	6,00/3,00	2150
MOD. "MEDIUM LARGE" (ML)		FOR ROWS OF mm 600-650-700 WORK mm 400-450-500 (BONNET)			
50-60	MSn/3ML	3	-	2,20	620
70-80	MSn/5ML (3+2)	5	4	3,00	900
70-80	MSnR/5ML (3+2)	5	4	3,20/2,50	1000
MOD. "LARGE" (L)		FOR ROWS OF mm 700-750-800 WORK mm 510-570-620 (BONNET)			
70-90	MSn/5L (3+2)	5	4	3,20	950
70-90	MSnR/5L (3+2)	5	4	3,20/2,50	1050
90-120	MSn/7L (5+2)	7	6	4,60	1250
90-120	MSnI/7L (5+2)	7	6	4,60/2,50	1300
90-120	MSnI/9L (7+2)	9	8	6,00/3,00	1950
MOD. "SUPER LARGE" (SL)		FOR ROWS OF mm 900-950-1000 WORK mm 670-720-770 (BONNET)			
50-70	MSn/2SL	2	2	2,00	530
60-75	MSn/3SL (1+2)	3	3	2,40	710
MOD. "EXTRA LARGE" (XL)		FOR ROWS OF mm 1200-1300 WORK mm 1000 (BONNET)			
60-75	MSn/2XL	2	2	2,00	570

MSn/ = fixed frame  
 MSnR/ = mechanical folding frame  
 MSnI/ = hydraulic folding frame

**MSn/**

blades  
5145C

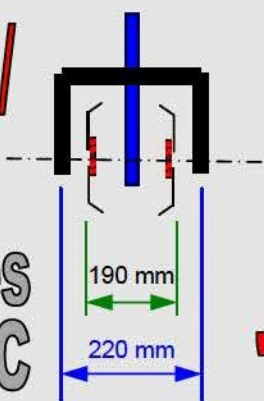

**"SS"**

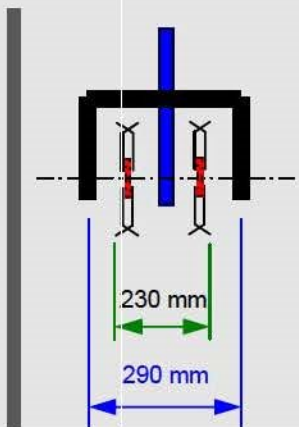

**"ST"**

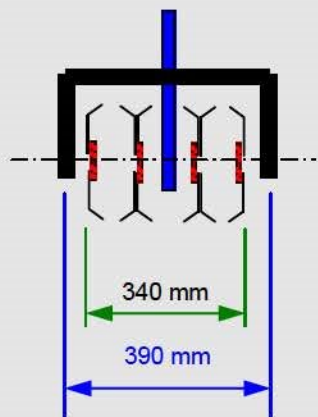
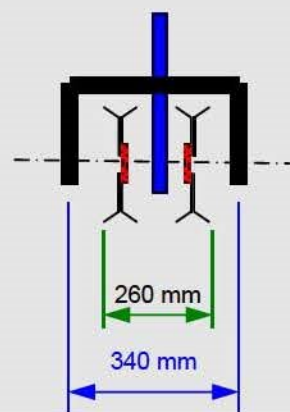

**"ML"**

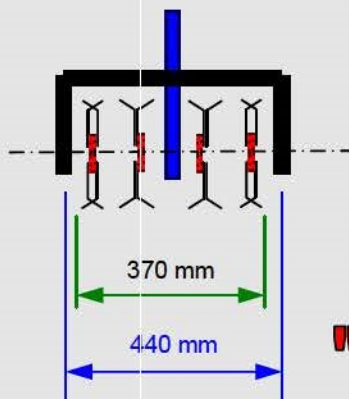

**"ML"**

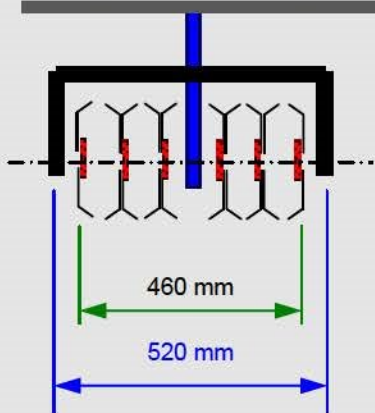
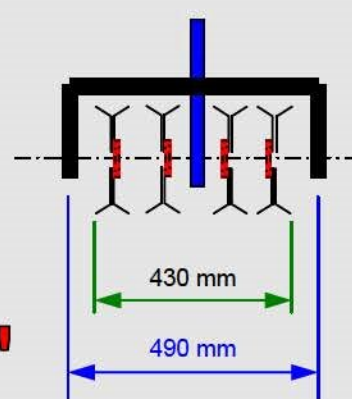

**"L"**

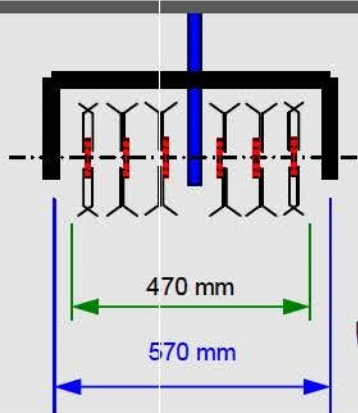

**"L"**

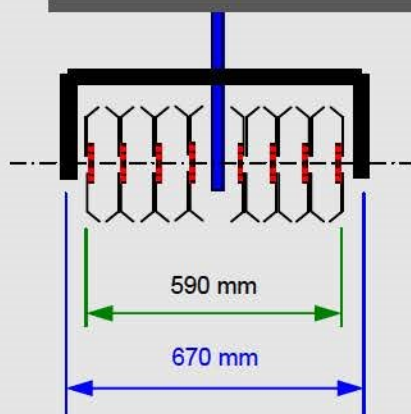
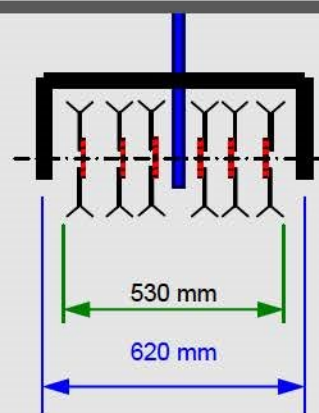

**"SL"**

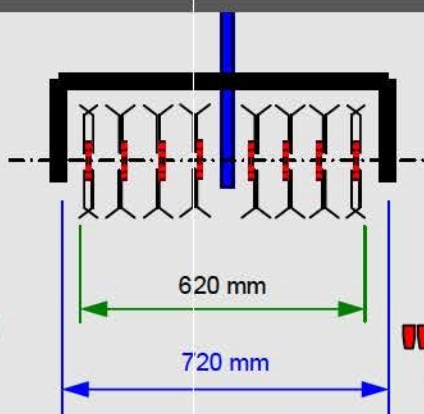

**"SL"**

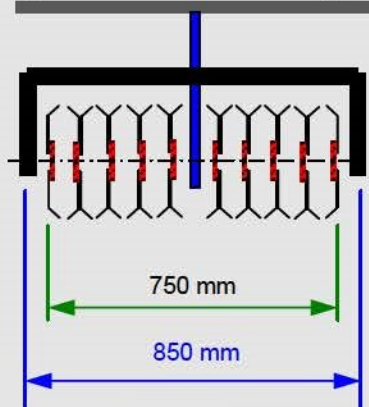
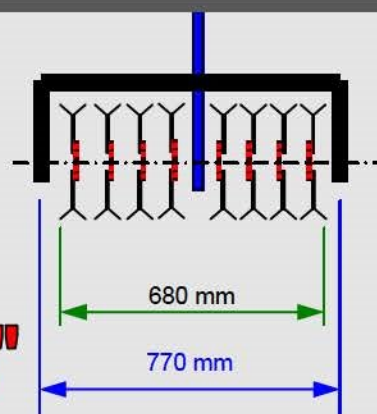

**"XL"**

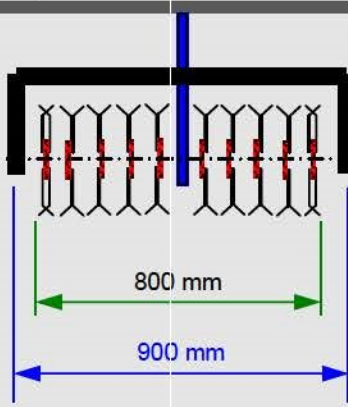

**"XL"**

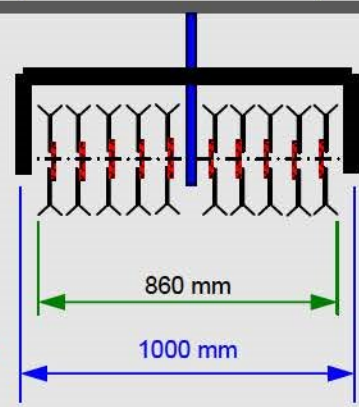



# SPECIAL MULTI-ROW ROTOTILLERS **ZEUS** **SUPER 5802**





# MZsa/

- ⇒ MODELS SUITABLE FOR NURSERIES, VEGETABLES AND FOR AGRICULTURAL PRODUCTS. For example WILLOWS, LITTLE TREES, ROSES, ARTICHOKEs, STRAWBERRIES, TOMATOES AND ALL OTHER CULTIVATION IN ROWS.
- ⇒ **REINFORCED HIGH QUALITY CHAINS ASA 100H.**
- ⇒ **BLADES** SUITABLE TO MINCE THE SOIL AND TO MAKE IT THIN AND PLAIN TO FACILITATE THE WORK OF HARVESTING MACHINES; THEY ARE PROPER FOR CULTIVATIONS LIKE TOMATOES AND VEGETABLES.
- ⇒ **HIGH RESISTANT BOLTS 12 mm** FOR BLADES.
- ⇒ **FRAME IN CAST STEEL THAT DOES NOT BEND,** ALSO IN LONG MODELS UNTIL 6 METERS. EASY MOVE OF THE WORKING UNITS WHICH SLIDE ON THE FRAME AS ON A RAIL.
- ⇒ **FRONT TINE** ON EACH UNIT TO MOVE THE SOIL WHERE IT IS NOT WORKED BY THE BLADES, ALSO IN COMPACT AND HARD SOILS.

**MZsa/:** HEXAGONAL TRANSMISSION SHAFT **50 mm**  
 MEASURE OF THE FRAME IN SECTION **150 mm**

## FRAME SECTION

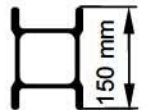

**MZsa/  
 blades  
 code  
 5802**

STANDARD EQUIPMENT:  
*CE Regulations equipments*  
*Cardan shaft with safety bolt*  
*High resistant blades and bolts*  
*Hexagonal transmission shaft 50 mm*  
*ASA 100 H Chain*  
*Strengthened front tine*  
*Oscillant protections*  
*Couple wheels with bearings D=360 mm*  
*Chain box in cast steel with side window*  
*Frame in cast steel*

**ZEUS  
 SUPER**

### Code 5802

mm 60x6

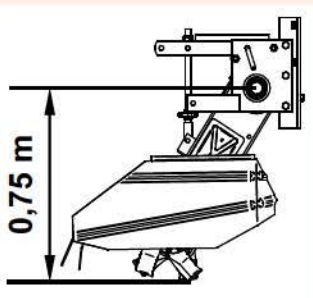
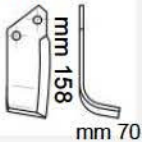

MOD. "LARGE" (L)			FOR ROWS OF mm 700-750-800 WORK mm 520-670 (BONNET)			
HP	MODEL	UNITS NR.	ROWS NR.	BONNET mm	FRAME m	WEIGHT kg
60-80	MZsa/2L	2	2	480-520	2,00	560
70-90	MZsa/3L	3	3	480-520	2,40	710
80-100	MZsa/5L	5	4	480-520	3,00	1150
MOD. "SUPER LARGE" (SL)			FOR ROWS OF mm 900-950-1000 WORK mm 700-850 (BONNET)			
HP	MODEL	UNITS NR.	ROWS NR.	BONNET mm	FRAME m	WEIGHT kg
60-80	MZsa/2SL	2	2	670-780-850	2,00	680
70-90	MZsa/3SL	3	3	670-780-850	2,40	850
80-120	MZsa/5 (3SL+2L)	5	4	670-780-850	4,50	1350
MOD. "EXTRA LARGE" (XL)			FOR ROWS OF mm 1200-1300 WORK mm 900-1100 (BONNET)			
HP	MODEL	UNITS NR.	ROWS NR.	BONNET mm	FRAME m	WEIGHT kg
60-80	MZsa/2XL	2	2	1000-1100-1160	2,00	740
70-100	MZsa/3XL	3	3	1000-1100-1160	2,40	930
80-120	MZsa/4 (2XL+2SL)	5	3	1300-1400-1550	HYDRAULIC	1400
80-120	MZsa/5 (3XL+2L)	5	4	1000-1100-1160	4,50	1450
MOD. "EXT. EXTRA LARGE" (XXL)			FOR ROWS OF mm 1300-1600 WORK mm 1120-1220-1320 (BONNET)			
HP	MODEL	UNITS NR.	ROWS NR.	BONNET mm	FRAME m	WEIGHT kg
60-80	MZsa/2XXL	2	2	1300-1400-1550	2,40	740
70-100	MZsa/3XXL	3	3	1300-1400-1550	2,40	950

MZsa/es 50

blades  
5802

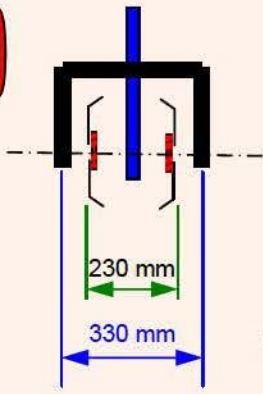

"ST"

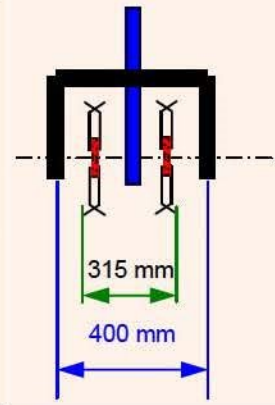

"ML"

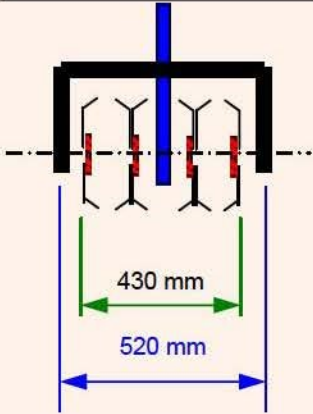
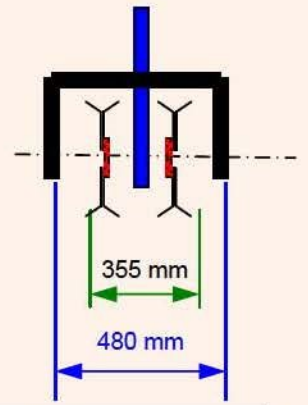

"L"

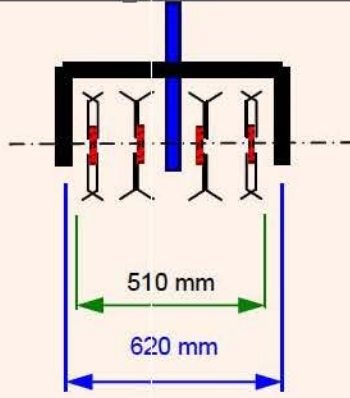

"L"

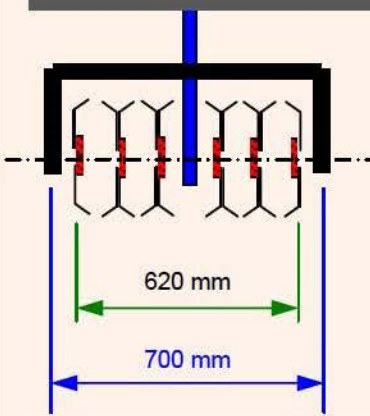
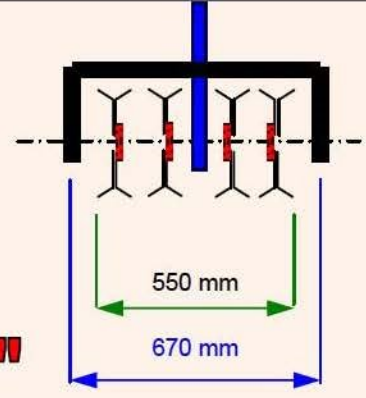

"SL"

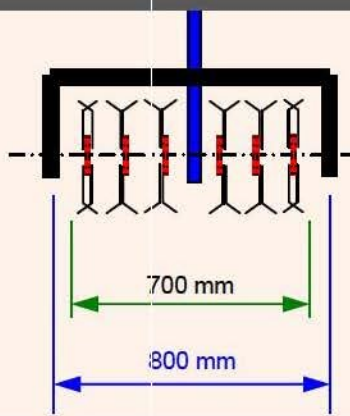

"SL"

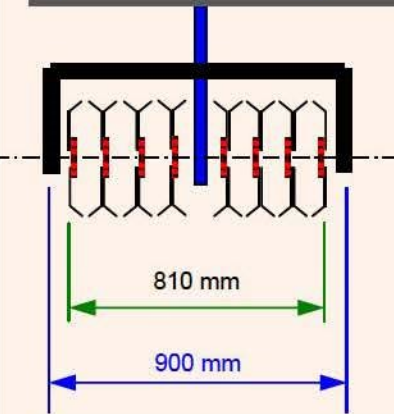
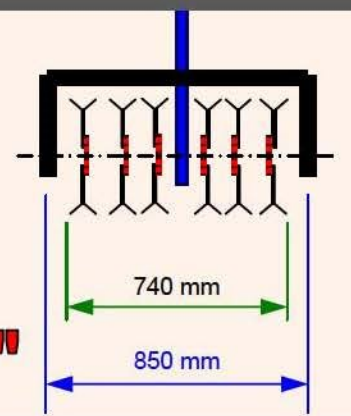

"XL"

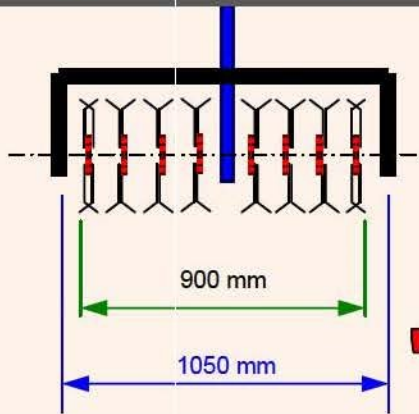

"XL"

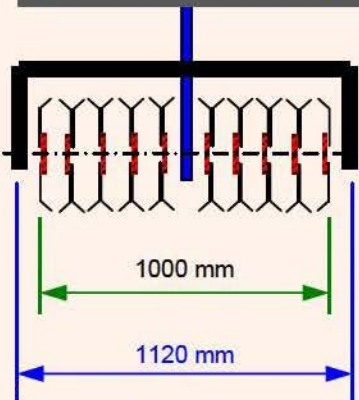
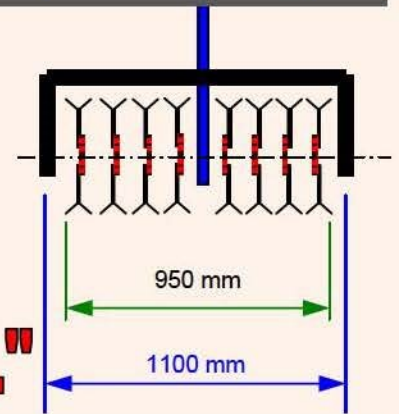

"XXL"

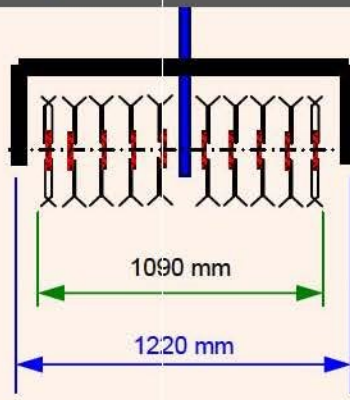

"XXL"

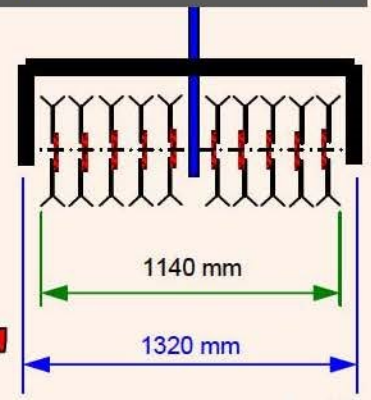



**ZEUS**



# SPECIAL MULTI-ROW ROTOTILLERS

# ZEUS SUPER 8914



# MZs/

- ⇒ MODELS SUITABLE FOR NURSERIES, VEGETABLES AND FOR AGRICULTURAL PRODUCTS. For example WILLOWS, LITTLE TREES, ROSES, ARTICHOKEs, STRAWBERRIES, TOMATOES AND ALL OTHER CULTIVATION IN ROWS.
- ⇒ **REINFORCED HIGH QUALITY CHAINS ASA 100H.**
- ⇒ STIFFENED **BLADES** WITH HIGH RESISTANT BOLTS OF 12mm FOR HEAVY WORK ALSO IN DEPTH AND FOR HARD, CLAYEY AND STONY SOILS.
- ⇒ **FRAME IN CAST STEEL THAT DOES NOT BEND**, ALSO IN LONG MODELS UNTIL 6 METERS. EASY MOVE OF THE WORKING UNITS WHICH SLIDE ON THE FRAME AS ON A RAIL.
- ⇒ **FRONT TINE** ON EACH UNIT TO MOVE THE SOIL WHERE IT IS NOT WORKED BY THE BLADES, ALSO IN COMPACT AND HARD SOILS.
- ⇒ **DIFFERENCES:**

**MZs/:** HEXAGONAL TRANSMISSION SHAFT 50 mm

MEASURE OF THE FRAME IN SECTION 150 mm

**FRAME SECTION**

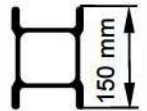

**MZs/  
blades  
code  
8914**

STANDARD EQUIPMENT:  
*CE Regulations equipments*  
*Cardan shaft with safety bolt*  
*High resistant blades and bolts*  
*Hexagonal transmission shaft 50 mm*  
*ASA 100 H Chain*  
*Strengthened front tine*  
*Oscillant protections*  
*Couple wheels with bearings D=360 mm*  
*Chain box in cast steel with side window*  
*Frame in cast steel*

**ZEUS  
SUPER**

**Code 8914**

mm 60x6



mm 90

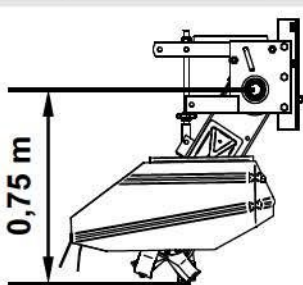

MOD. "LARGE" (L)		FOR ROWS OF mm 700-750-800 WORK mm 480-520 (BONNET)				
HP	MODEL	UNITS NR.	ROWS NR.	BONNET mm	FRAME m	WEIGHT kg
60-80	MZs/2L	2	2	480-520	2,00	560
70-90	MZs/3L	3	3	480-520	2,40	710
80-100	MZs/5L	5	4	480-520	3,00	1150
MOD. "SUPER LARGE" (SL)		FOR ROWS OF mm 900-950-1000 WORK mm 670-850 (BONNET)				
HP	MODEL	UNITS NR.	ROWS NR.	BONNET mm	FRAME m	WEIGHT kg
60-80	MZs/2SL	2	2	670-780-850	2,00	680
70-90	MZs/3SL	3	3	670-780-850	2,40	850
80-120	MZs/5 (3SL+2L)	5	4	670-780-850	4,50	1350
MOD. "EXTRA LARGE" (XL)		FOR ROWS OF mm 1200-1300 WORK mm 1000-1160 (BONNET)				
HP	MODEL	UNITS NR.	ROWS NR.	BONNET mm	FRAME m	WEIGHT kg
60-80	MZs/2XL	2	2	1000-1100-1160	2,00	740
70-100	MZs/3XL	3	3	1000-1100-1160	2,40	930
80-120	MZs/5 (3XL+2L)	5	4	1000-1100-1160	4,50	1450
MOD. "EXT. EXTRA LARGE" (XXL)		FOR ROWS OF mm 1300-1600 WORK mm 1300-1550 (BONNET)				
HP	MODEL	UNITS NR.	ROWS NR.	BONNET mm	FRAME m	WEIGHT kg
60-80	MZs/2XXL	2	2	1300-1400-1550	2,40	740
70-100	MZs/3XXL	3	3	1300-1400-1550	2,40	950
80-120	MZs/4 (2XXL+2SL)	5	3	1300-1400-1550	HYDRAULIC	1400

**MZs/ es 50**

**blades  
8914**

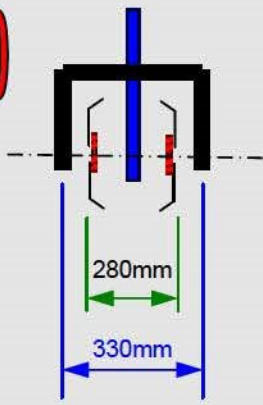

**"ML"**

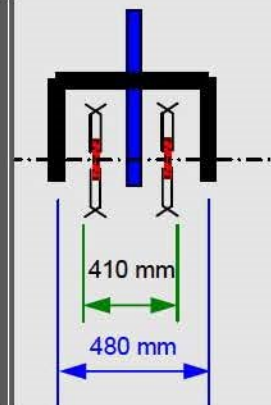

**"L"**

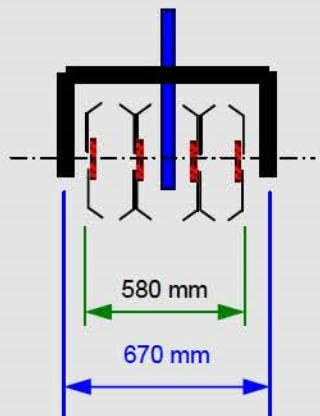
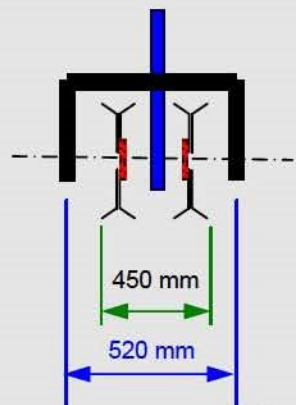

**"SL"**

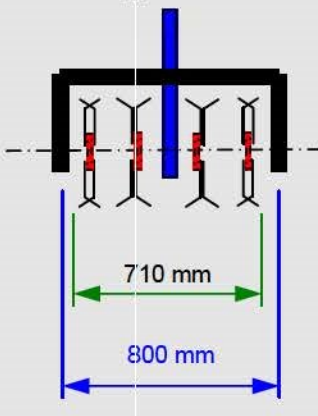

**"SL"**

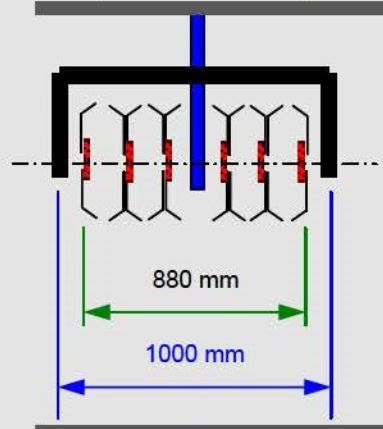
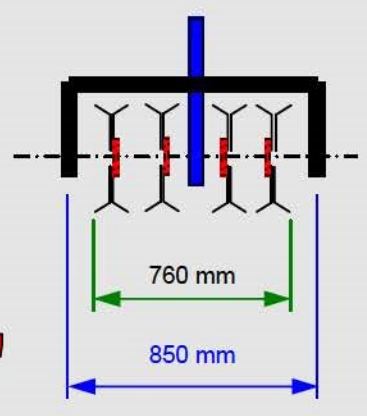

**"XL"**

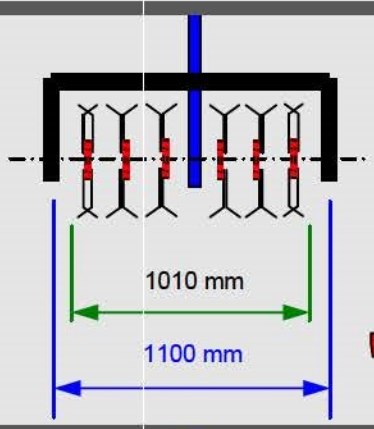

**"XL"**

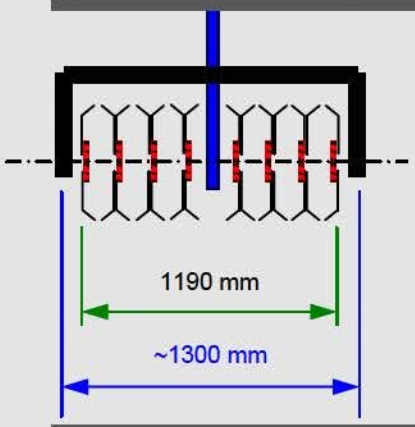
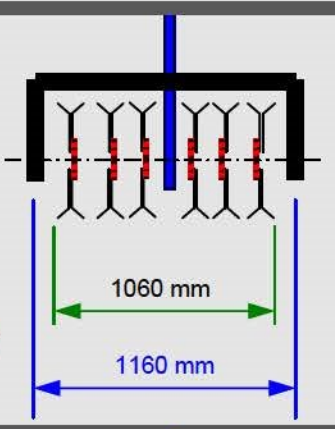

**"XXL"**

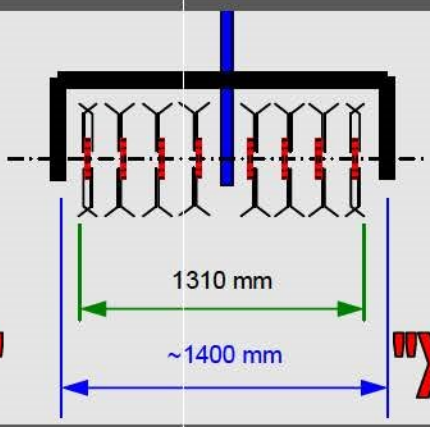

**"XXL"**

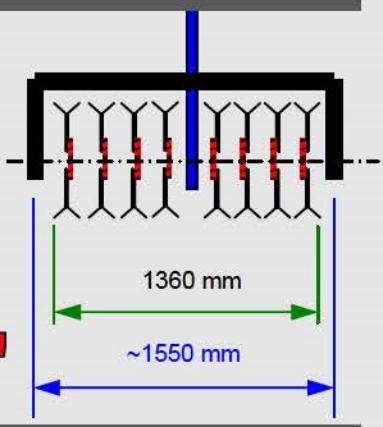







# MTs/

## FRAME SECTION

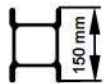

### EQUIPMENT:

- EC safety guards*
- Cardan shaft with safety bolts*
- Oversized blades and bolts*
- Hexagonal transmission shaft = 50 mm*
- Chain ASA 120*
- Couple wheels with bearings D=360 mm*
- Chain box in cast steel with side window for inspection*
- Strengthened front tine*
- Frame in cast steel*



MOD. "LARGE" (L)		FOR ROWS OF mm 750-800 WORK mm 580 (BONNET)			
HP	MODEL	UNITS NR.	BONNET mm	FRAME m	WEIGHT kg
70-100	MTs/2L	2	580	2,00	850
MOD. "SUPER LARGE" (SL)		FOR ROWS OF mm 900-1000 WORK mm 660-740-810 (BONNET)			
70-100	MTs/2SL	2	660-740-810	2,00	900
70-100	MTs/2SL	2	660-740-810	2,40	900
MOD. "EXTRA LARGE" (XL)		FOR ROWS OF mm 810-890-1040			
70-110	MTs/2XL	2	810-890-1040	2,40	920
MOD. "EXTRA EXTRA LARGE" (XXL)		FOR ROWS OF mm 1400-1800 WORK mm 1200-1500 (BONNET)			
70-110	MTs/2XXL	2	1200-1500	2,40	960
100-130	MTs/3 2XXL+1L	3	1200-1500	3,80	1200
100-130	MTs/3 2XXL+1L	3	1200-1500	HYDRAULIC	1500
100-130	MTs/4 2XXL+2SL	4	1200-1500	HYDRAULIC	1700

## Code 5261

mm 80x8

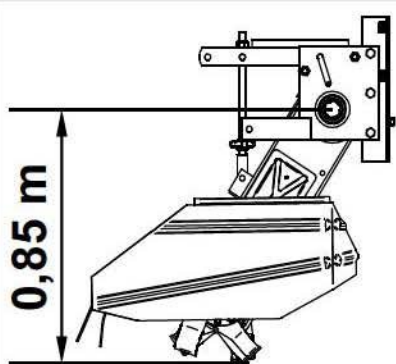
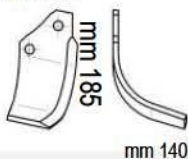

# MTs/ es 50

## blades 5261

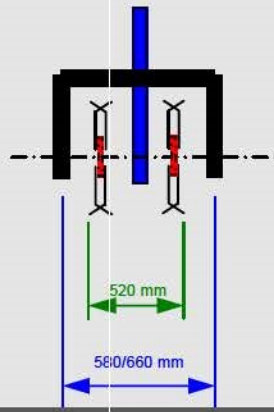

**"L"**

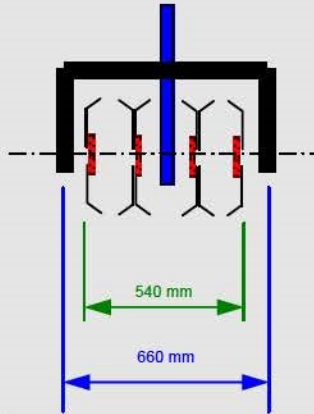
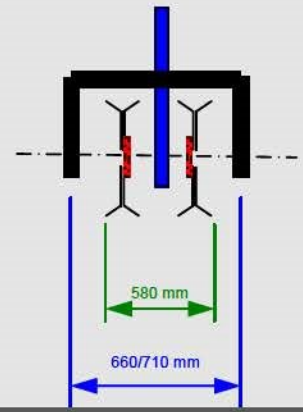

**"SL"**

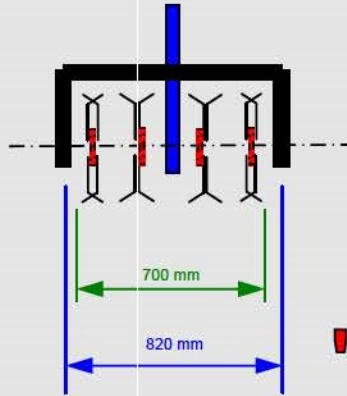

**"SL"**

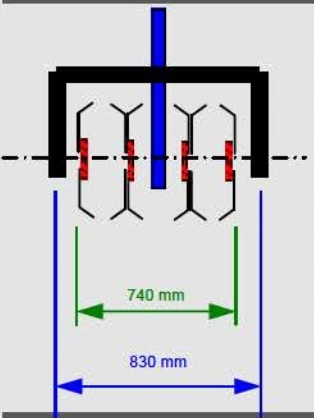
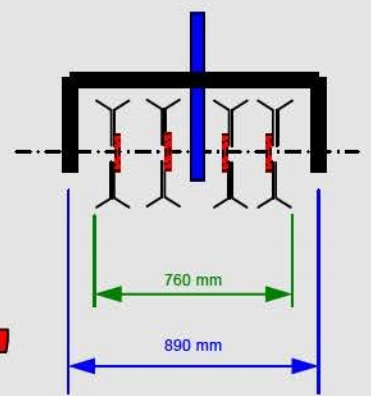

**"XL"**

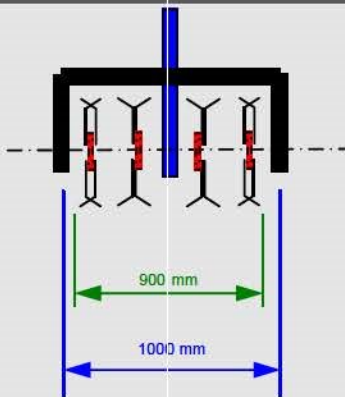

**"XL"**

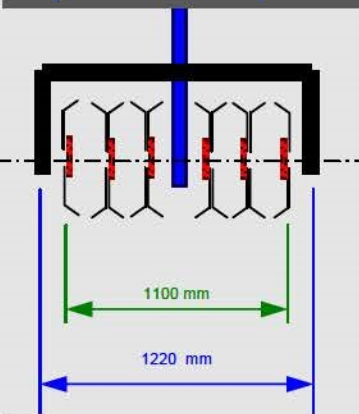
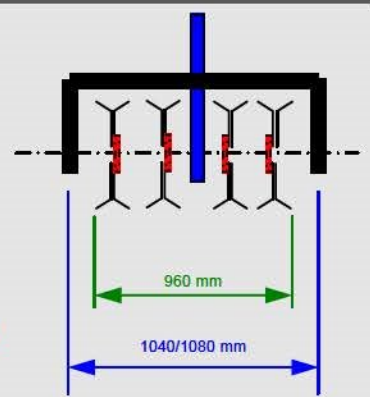

**"XXL"**

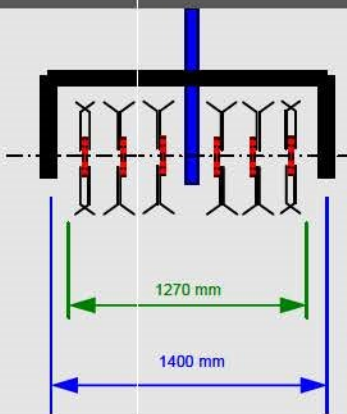

**"XXL"**

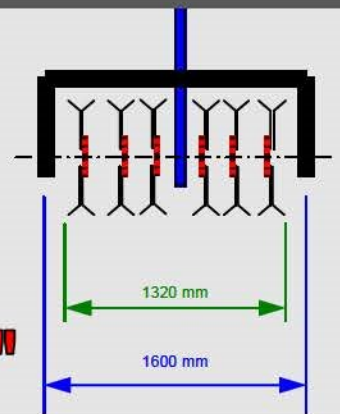



EQUIPMENT:

- EC safety guards*
- Cardan shaft with safety bolts*
- Oversized blades and bolts*
- Hexagonal transmission shaft = 50 mm*
- Chain ASA 120*
- Couple wheels with bearings D=360 mm*
- Chain box in cast steel with side window*
- Strengthened front tine*
- Frame in cast steel*



MOD. "EXTRA LARGE" (XL)			FOR ROWS OF mm 1000-1800 WORK mm 810 (BONNET)			
HP	MODEL	UNITS NR.	ROWS NR.	BONNET mm	FRAME m	WEIGHT kg
80-110	MTx/2XL	2	2	810	2,40	1000
80-130	MTx/3XL	3	3	810	3,00	1250

ON REQUEST:

- Transmission shaft protections
- SET OF SPRINGS ON BACK BAND OF THE TILLING UNIT**
- Hydraulic cylinders for regulation of side units**
- Side handles for regulation**
- 1000 rpm gear box



# STONEBURIER

# MTx/

# TITANO

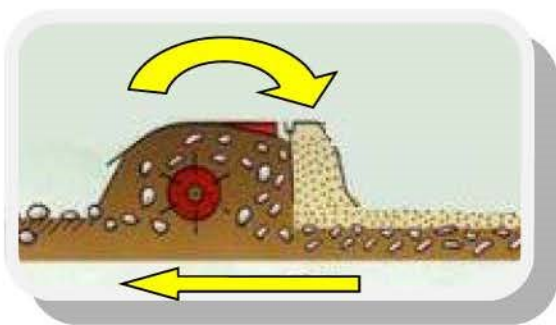

FRAME SECTION

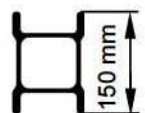

**Code 5261**

mm 80x8

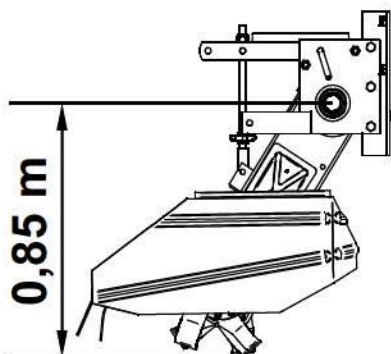
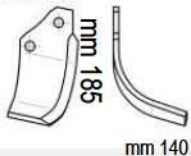



**瑋洲企業有限公司**



地址：台灣高雄市前鎮區武德街135巷24號

信件請寄：高雄市郵政信箱1394號

Tel：07-7169249 Fax：07-2134620

E-Mail:agri-machine@weizhou.com.tw

Line：weizohu1995 Skype：service450429 QQ：1467808036

Viber:+886972326392 WhatsApp:+886972326392 Wechat:walterhsu1995

<http://www.weizhou.com.tw/Agrimachine/index-export.htm>